

MADE IN ITALY. MADE TO EXCEL.

LOG

Interactive version



WOOD LOOK

WALL TILES

Rivestimenti
Revêtements
Wandfliesen
Revestimientos
Настенная плитка

PORCELAIN TILES

Gres Porcellanato
Grès cérame
Feinsteinzeug
Gres porcelánico
Керамический гранит



Atlas Concorde is one of the leading global brands in the production of ceramic tiles and large slabs for design and architecture. With over 50 years of history, two production plants, and numerous showroom in the capitals of international design, Atlas Concorde offers integrated and sustainable ceramic systems for floors, walls, outdoor spaces, worktops, bathroom furnishings, facades and special projects. Design your world with Atlas Concorde.

Atlas Concorde è uno dei principali brand mondiali nella produzione di superfici e grandi lastre ceramiche per il design e l'architettura. Con oltre cinquant'anni di storia, due stabilimenti produttivi, numerose showroom nelle capitali della progettazione internazionale, offriamo sistemi ceramici integrati e sostenibili per pavimenti, rivestimenti, outdoor, piani di lavoro, arredo bagno, facciate e progetti speciali. Design your world with Atlas Concorde.

atlasconcorde.com

INDEX

- ↳ INSPIRATION
- ↳ IMAGE GALLERY
- ↳ SURFACE RANGE & TECHNICAL SPECIFICATION

INDEX



INSPIRATION



IMAGE GALLERY



SURFACE RANGE & TECHNICAL SPECS



ENJOY THE VIDEO





TRUE TO NATURE

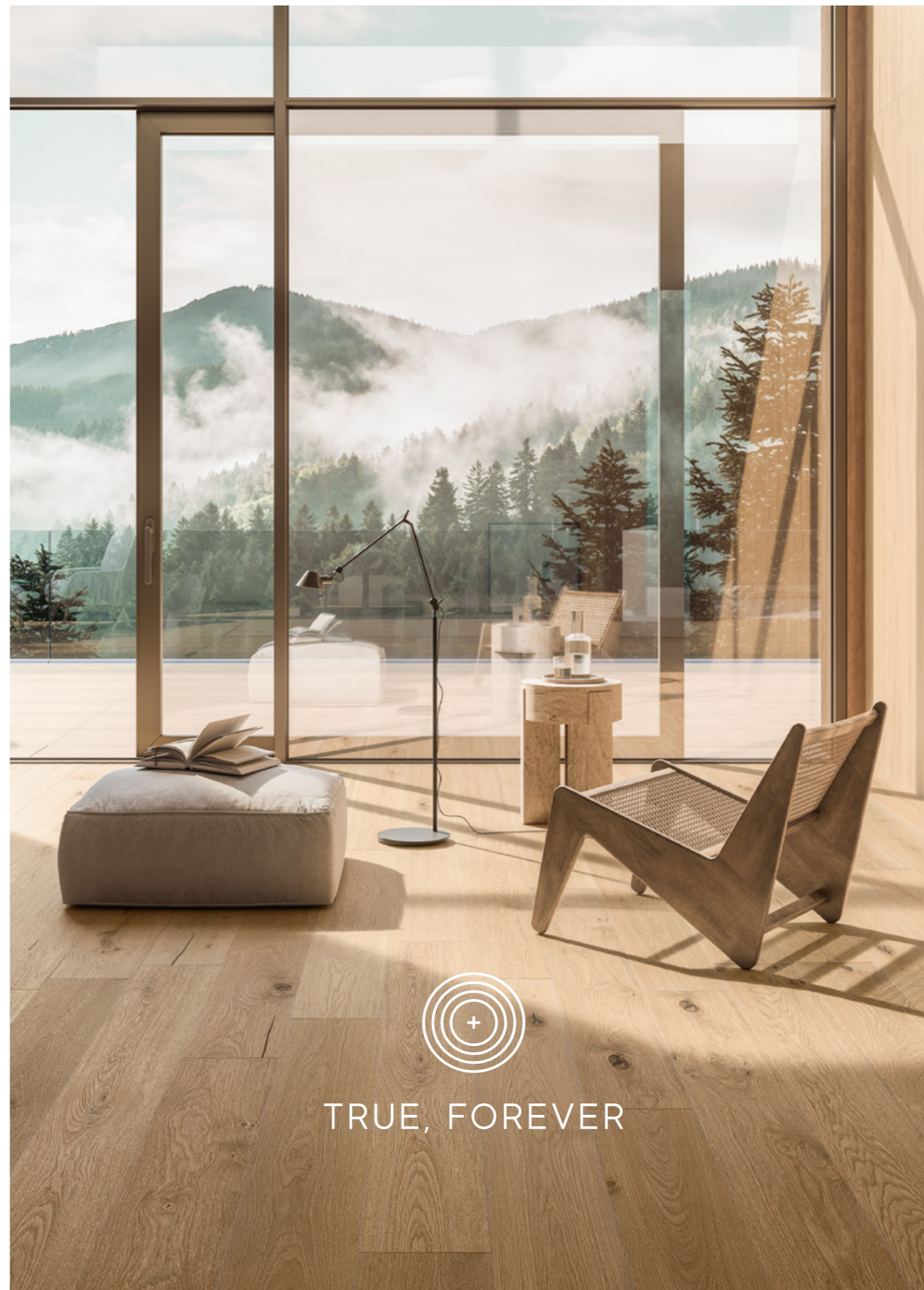

TRUE, FOREVER

INDEX



INSPIRATION



IMAGE
GALLERY



SURFACE
RANGE &
TECHNICAL
SPECS



ENJOY
THE VIDEO



COMBINED EXPERTISE, SUPERIOR EXCELLENCE



"We went looking for the secrets of wood where they have always been kept. We recreated them using our expertise in ceramic tiles, for a collection with authentic beauty."

Maurizio Mazzotti
CEO - Atlas Concorde

"A synergy between two family businesses that care about Made in Italy, innovation, and development of new surfaces."

Patrizio Dei Tos
President - Itlas



INDEX



INSPIRATION



IMAGE
GALLERY



SURFACE
RANGE &
TECHNICAL
SPECS



ENJOY
THE VIDEO



NATURAL BEAUTY, STYLED YOUR WAY



"Oak, its knots, cracks, and holes,
are natural features to be valued."

Matteo Dei Tos
CEO - Itlas



Surface characteristics



Surface characteristics



INDEX



INSPIRATION



IMAGE GALLERY



SURFACE RANGE & TECHNICAL SPECS



ENJOY THE VIDEO





BORN FROM NATURE

INDEX



INSPIRATION



IMAGE GALLERY



SURFACE RANGE & TECHNICAL SPECS



ENJOY THE VIDEO



TO FIT ALL APPLICATIONS



INDOOR ORIGIN, OUTDOOR PERFECTION



Image Gallery

Icon Oak - Residential Villa In&Out

Icon Oak - Urban Loft

Moon Oak - Home Bathroom

Deep Oak - Concept Store



Amber Oak - Hotel Lounge

Bright Oak - Luxury Hotel

Bright Oak - Junior Suite



INDEX



INSPIRATION



IMAGE GALLERY



ICON OAK
 RESIDENTIAL VILLA IN&OUT
 ICON OAK - URBAN LOFT
 MOON OAK - HOME BATHROOM
 DEEP OAK - CONCEPT STORE
 AMBER OAK - HOTEL LOUNGE
 BRIGHT OAK - LUXURY HOTEL
 BRIGHT OAK - JUNIOR SUITE

SURFACE RANGE & TECHNICAL SPECS



ENJOY THE VIDEO



ICON OAK



Log Icon Oak
20x120 cm | 77/8" x 47/4"



Image gallery

INDEX



INSPIRATION



IMAGE GALLERY



- ICON OAK
- RESIDENTIAL VILLA IN&OUT
- ICON OAK - URBAN LOFT
- MOON OAK - HOME BATHROOM
- DEEP OAK - CONCEPT STORE
- AMBER OAK - HOTEL LOUNGE
- BRIGHT OAK - LUXURY HOTEL
- BRIGHT OAK - JUNIOR SUITE

SURFACE RANGE & TECHNICAL SPECS



ENJOY THE VIDEO





FLOOR	WALL	Log	FURNITURE
Log	Log	Icon Oak	Atlas Plan
Icon Oak	Icon Oak Line	Matte	Boost Icor Bone
Matte Sensitech	Matte	Hammered	
20x120 cm 7 ⁷ / ₈ "x47 ¹ / ₄ "	120x278 cm 47 ¹ / ₄ "x109 ¹ / ₂ "	120x278 cm 47 ¹ / ₄ "x109 ¹ / ₂ "	162x324 cm 63 ³ / ₄ "x127 ¹ / ₂ "

INDEX



INSPIRATION



IMAGE GALLERY



ICON OAK
RESIDENTIAL VILLA IN&OUT
ICON OAK - URBAN LOFT
MOON OAK - HOME BATHROOM
DEEP OAK - CONCEPT STORE
AMBER OAK - HOTEL LOUNGE
BRIGHT OAK - LUXURY HOTEL
BRIGHT OAK - JUNIOR SUITE

SURFACE RANGE & TECHNICAL SPECS



ENJOY THE VIDEO





FLOOR

Log
Icon Oak
 Matte Sensitech
 20x120 cm | 7⁷/₈"x47¹/₄"

WALL

Log
Icon Oak
 Matte
 120x278 cm | 47¹/₄"x109¹/₂"

Log
Icon Oak Line
 Matte
 120x278 cm | 47¹/₄"x109¹/₂"

FURNITURE

Atlas Plan
Boost Icor Bone
 Hammered
 162x324 cm | 63³/₄"x127¹/₂"

DINING TABLE | INCONTRO 75

Atlas Concorde Habitat
Calacatta Prestigio
 Silk
 100x180 cm | 39³/₈"x70⁷/₈"



INDEX 



INSPIRATION 

IMAGE GALLERY 

- ICON OAK
- RESIDENTIAL VILLA IN&OUT
- ICON OAK - URBAN LOFT
- MOON OAK - HOME BATHROOM
- DEEP OAK - CONCEPT STORE
- AMBER OAK - HOTEL LOUNGE
- BRIGHT OAK - LUXURY HOTEL
- BRIGHT OAK - JUNIOR SUITE

SURFACE RANGE & TECHNICAL SPECS 

ENJOY THE VIDEO 



^
 FLOOR
Log
Icon Oak Modern Frame 1
 Matte Sensitech
 120x120 cm | 47¹/₄"x47¹/₄"

DINING TABLE | **INCONTRO 75**
Atlas Concorde Habitat
Calacatta Prestigio
 Silk
 100x180 cm | 39³/₈"x70¹/₈"

<
 FLOOR
Log
Icon Oak
 Matte Sensitech
 20x120 cm | 7⁷/₈"x47¹/₄"

WALL
Log
Icon Oak Line
 Matte
 120x278 cm | 47¹/₄"x109¹/₂"

INDEX



INSPIRATION



IMAGE GALLERY



ICON OAK
 RESIDENTIAL VILLA IN&OUT
 ICON OAK - URBAN LOFT
 MOON OAK - HOME BATHROOM
 DEEP OAK - CONCEPT STORE
 AMBER OAK - HOTEL LOUNGE
 BRIGHT OAK - LUXURY HOTEL
 BRIGHT OAK - JUNIOR SUITE

SURFACE RANGE & TECHNICAL SPECS



ENJOY THE VIDEO





OUTDOOR FLOOR
 Log
 Icon Oak Deck
 Outdoor Sensitech \pm 20mm
 60x120 cm | 23 $\frac{5}{8}$ "x47 $\frac{1}{4}$ "

Log
 Icon Oak Forest
 Outdoor Sensitech \pm 20mm
 30x120 cm | 11 $\frac{3}{4}$ "x47 $\frac{1}{4}$ "

OUTDOOR WALL
 Boost Balance
 White
 Matté
 120x278 cm | 47 $\frac{1}{4}$ "x109 $\frac{1}{2}$ "

INDEX



INSPIRATION



IMAGE GALLERY



ICON OAK
 RESIDENTIAL VILLA IN&OUT
 ICON OAK - URBAN LOFT
 MOON OAK - HOME BATHROOM
 DEEP OAK - CONCEPT STORE
 AMBER OAK - HOTEL LOUNGE
 BRIGHT OAK - LUXURY HOTEL
 BRIGHT OAK - JUNIOR SUITE

SURFACE RANGE & TECHNICAL SPECS



ENJOY THE VIDEO





OUTDOOR FLOOR
Log
Icon Oak Deck
 Outdoor Sensitech \pm 20mm
 60x120 cm | 23⁵/₈"x47¹/₄"

Log
Icon Oak Forest
 Outdoor Sensitech \pm 20mm
 30x120 cm | 11³/₄"x47¹/₄"

OUTDOOR WALL
Boost Balance
White
 Matte
 120x278 cm | 47¹/₄"x109¹/₂"

COFFEE TABLE | **BROOKLYN 25**
Atlas Concorde Habitat
Calacatta Prestigio
 Silk
 60x90 cm | 23⁵/₈"x35³/₈"

INDEX



INSPIRATION



IMAGE GALLERY



- ICON OAK
- RESIDENTIAL VILLA IN&OUT
- ICON OAK - URBAN LOFT
- MOON OAK - HOME BATHROOM
- DEEP OAK - CONCEPT STORE
- AMBER OAK - HOTEL LOUNGE
- BRIGHT OAK - LUXURY HOTEL
- BRIGHT OAK - JUNIOR SUITE

SURFACE RANGE & TECHNICAL SPECS



ENJOY THE VIDEO





FLOOR
 Log
 Icon Oak Chevron
 Matte
 7,5x45 cm | 3"x17¹/₄"

WALL
 Log
 Icon Oak
 Matte
 120x278 cm | 47¹/₄"x109¹/₂"

FURNITURE
 Atlas Plan
 Travertine White Vein Cut
 Hammered
 162x324 cm | 63³/₄"x127¹/₂"

SIDE TABLE | CONTATTO
 Atlas Concorde Habitat
 Nero Marquinia
 Silk
 45x45 cm | 17²/₄"x17²/₄"

INDEX



INSPIRATION



IMAGE GALLERY



- ICON OAK - RESIDENTIAL VILLA IN&OUT
- ICON OAK - URBAN LOFT
- MOON OAK - HOME BATHROOM
- DEEP OAK - CONCEPT STORE
- AMBER OAK - HOTEL LOUNGE
- BRIGHT OAK - LUXURY HOTEL
- BRIGHT OAK - JUNIOR SUITE

SURFACE RANGE & TECHNICAL SPECS



ENJOY THE VIDEO





FLOOR

Log
Icon Oak Chevron
 Matte
 7,5x45 cm | 3"x17 1/4"

Log
Icon Oak
 Matte Sensitech
 20x120 cm | 7 7/8"x47 1/4"

WALL

Log
Icon Oak
 Matte
 120x278 cm | 47 1/4"x109 1/2"



INDEX



INSPIRATION



IMAGE GALLERY



ICON OAK - RESIDENTIAL VILLA IN&OUT
 ICON OAK - URBAN LOFT
 MOON OAK - HOME BATHROOM
 DEEP OAK - CONCEPT STORE
 AMBER OAK - HOTEL LOUNGE
 BRIGHT OAK - LUXURY HOTEL
 BRIGHT OAK - JUNIOR SUITE

SURFACE RANGE & TECHNICAL SPECS



ENJOY THE VIDEO





FLOOR
Log
 Icon Oak Classic Frame
 Matte Sensitech
 120x120 cm | 47¹/₄"x47¹/₄"

WALL
Log
 Icon Oak
 Matte
 120x278 cm | 47¹/₄"x109¹/₂"

DINING TABLE | **INCONTRO 75**
 Atlas Concorde Habitat
 Nero Marquinia
 Silk
 100x240 cm | 39³/₈"x94¹/₂"

INDEX



INSPIRATION



IMAGE GALLERY



ICON OAK
 RESIDENTIAL VILLA IN&OUT
 ICON OAK - URBAN LOFT
 MOON OAK - HOME BATHROOM
 DEEP OAK - CONCEPT STORE
 AMBER OAK - HOTEL LOUNGE
 BRIGHT OAK - LUXURY HOTEL
 BRIGHT OAK - JUNIOR SUITE

SURFACE RANGE & TECHNICAL SPECS



ENJOY THE VIDEO





OUTDOOR FLOOR
Log
Icon Oak Forest
 Outdoor Sensitech ± 20mm
 30x120 cm | 11³/₄"x47¹/₄"

DINING TABLE | **BROOKLYN 75**
Atlas Concorde Habitat
Calacatta Meraviglia
 Silk
 100x180 cm | 39³/₈"x70⁷/₈"

SIDE TABLE | **CONTATTO**
Atlas Concorde Habitat
Calacatta Meraviglia
 Silk
 ø 70 cm | 27¹/₂"

INDEX



INSPIRATION



IMAGE GALLERY



ICON OAK - RESIDENTIAL VILLA IN&OUT
 ICON OAK - URBAN LOFT
 MOON OAK - HOME BATHROOM
 DEEP OAK - CONCEPT STORE
 AMBER OAK - HOTEL LOUNGE
 BRIGHT OAK - LUXURY HOTEL
 BRIGHT OAK - JUNIOR SUITE

SURFACE RANGE & TECHNICAL SPECS



ENJOY THE VIDEO



MOON OAK



Log Moon Oak
20x120 cm | 7⁷/₈"x47¹/₄"



INDEX



INSPIRATION



IMAGE GALLERY



- ICON OAK - RESIDENTIAL VILLA IN&OUT
- ICON OAK - URBAN LOFT
- MOON OAK - HOME BATHROOM
- DEEP OAK - CONCEPT STORE
- AMBER OAK - HOTEL LOUNGE
- BRIGHT OAK - LUXURY HOTEL
- BRIGHT OAK - JUNIOR SUITE

SURFACE RANGE & TECHNICAL SPECS



ENJOY THE VIDEO





FLOOR
Log
Moon Oak
Matte Sensitech
20x120 cm | 7⁷/₈"x47¹/₄"

WALL
Log
Moon Oak 3D Pleat
Matte
50x120 cm | 19⁵/₈"x47¹/₄"

TWIN SINK | EVOLUZIONE - DUO
Atlas Concorde Habitat
Boost Icor Dust Matte
Rectangular White Basin
160x45x12 cm | 63"x17³/₄"x4³/₄"

SHELF | ESSENZA - THIN
Atlas Concorde Habitat
Boost Icor Dust
Matte
160x45x5 cm | 63"x17³/₄"x2"

INDEX



INSPIRATION



IMAGE GALLERY



ICON OAK - RESIDENTIAL VILLA IN&OUT
 ICON OAK - URBAN LOFT
 MOON OAK - HOME BATHROOM
 DEEP OAK - CONCEPT STORE
 AMBER OAK - HOTEL LOUNGE
 BRIGHT OAK - LUXURY HOTEL
 BRIGHT OAK - JUNIOR SUITE

SURFACE RANGE & TECHNICAL SPECS



ENJOY THE VIDEO





FLOOR
Log
Moon Oak
 Matte Sensitech
 20x120 cm | 7⁷/₈"x47¹/₄"

WALL
Log
Moon Oak 3D Pleat
 Matte
 50x120 cm | 19⁵/₈"x47¹/₄"

TWIN SINK | EVOLUZIONE - DUO
Atlas Concorde Habitat
Boost Icor Dust Matte
Rectangular White Basin
 160x45x12 cm | 63"x17³/₄"x4³/₄"

SHELF | ESSENZA - THIN
Atlas Concorde Habitat
Boost Icor Dust
 Matte
 160x45x5 cm | 63"x17³/₄"x2"

INDEX



INSPIRATION



IMAGE GALLERY



ICON OAK - RESIDENTIAL VILLA IN&OUT
 ICON OAK - URBAN LOFT
 MOON OAK - HOME BATHROOM
 DEEP OAK - CONCEPT STORE
 AMBER OAK - HOTEL LOUNGE
 BRIGHT OAK - LUXURY HOTEL
 BRIGHT OAK - JUNIOR SUITE

SURFACE RANGE & TECHNICAL SPECS



ENJOY THE VIDEO





FLOOR
Log
Moon Oak
 Matte Sensitech
 20x120 cm | 7⁷/₈"x47¹/₄"

INDEX



INSPIRATION



IMAGE GALLERY



- ICON OAK - RESIDENTIAL VILLA IN&OUT
- ICON OAK - URBAN LOFT
- MOON OAK - HOME BATHROOM
- DEEP OAK - CONCEPT STORE
- AMBER OAK - HOTEL LOUNGE
- BRIGHT OAK - LUXURY HOTEL
- BRIGHT OAK - JUNIOR SUITE

SURFACE RANGE & TECHNICAL SPECS



ENJOY THE VIDEO



DEEP OAK



Log Deep Oak
20x120 cm | 7⁷/₈"x47¹/₄"



INDEX



INSPIRATION



IMAGE GALLERY



- ICON OAK - RESIDENTIAL VILLA IN&OUT
- ICON OAK - URBAN LOFT
- MOON OAK - HOME BATHROOM
- DEEP OAK - CONCEPT STORE**
- AMBER OAK - HOTEL LOUNGE
- BRIGHT OAK - LUXURY HOTEL
- BRIGHT OAK - JUNIOR SUITE

SURFACE RANGE & TECHNICAL SPECS



ENJOY THE VIDEO





FLOOR			WALL	FURNITURE
Log	Log	Marvel Diva	Log	Atlas Plan
Deep Oak	Deep Oak Chevron	Taj Mahal	Deep Oak 3D Pleat	Taj Mahal
Matte Sensitech	Matte	Matte Sensitech	Matte	Silk
20x120 cm 7 ⁷ / ₈ "x47 ¹ / ₄ "	7,5x45 cm 3"x17 ¹ / ₄ "	60x120 cm 23 ⁵ / ₈ "x47 ¹ / ₄ "	50x120 cm 19 ⁵ / ₈ "x47 ¹ / ₄ "	162x324 cm 63 ³ / ₄ "x127 ¹ / ₂ "

INDEX



INSPIRATION



IMAGE GALLERY



ICON OAK - RESIDENTIAL VILLA IN&OUT
 ICON OAK - URBAN LOFT
 MOON OAK - HOME BATHROOM
 DEEP OAK - CONCEPT STORE
 AMBER OAK - HOTEL LOUNGE
 BRIGHT OAK - LUXURY HOTEL
 BRIGHT OAK - JUNIOR SUITE

SURFACE RANGE & TECHNICAL SPECS



ENJOY THE VIDEO





FLOOR Log Chevron Deep Oak Matte 7,5x45 cm 3'x17 ³ / ₄ "	WALL Log Deep Oak 3D Pleat Matte 50x120 cm 19 ⁵ / ₈ "x47 ¹ / ₄ "	FURNITURE Atlas Plan Taj Mahal Silk 162x324 cm 63 ³ / ₄ "x127 ¹ / ₂ "
---	---	--



INDEX 

INSPIRATION 

IMAGE GALLERY 

- ICON OAK - RESIDENTIAL VILLA IN&OUT
- ICON OAK - URBAN LOFT
- MOON OAK - HOME BATHROOM
- DEEP OAK - CONCEPT STORE
- AMBER OAK - HOTEL LOUNGE
- BRIGHT OAK - LUXURY HOTEL
- BRIGHT OAK - JUNIOR SUITE

SURFACE RANGE & TECHNICAL SPECS 

ENJOY THE VIDEO 



FLOOR

Log
Deep Oak
 Matte Sensitech
 20x120 cm | 7¹/₈"x47¹/₄"

Log
Deep Oak Chevron
 Matte
 7,5x45 cm | 3'x17³/₄"

Marvel Diva
Taj Mahal
 Matte Sensitech
 60x120 cm | 23⁵/₈"x47¹/₄"

WALL

Log
Deep Oak 3D Pleat
 Matte
 50x120 cm | 19⁵/₈"x47¹/₄"

INDEX



INSPIRATION



IMAGE GALLERY



ICON OAK - RESIDENTIAL VILLA IN&OUT
 ICON OAK - URBAN LOFT
 MOON OAK - HOME BATHROOM
 DEEP OAK - CONCEPT STORE
 AMBER OAK - HOTEL LOUNGE
 BRIGHT OAK - LUXURY HOTEL
 BRIGHT OAK - JUNIOR SUITE

SURFACE RANGE & TECHNICAL SPECS



ENJOY THE VIDEO





WALL
 Log
 Deep Oak 3D Pleat
 Matte
 50x120 cm | 19⁵/₈"x47¹/₄"

INDEX



INSPIRATION



IMAGE GALLERY



- ICON OAK - RESIDENTIAL VILLA IN&OUT
- ICON OAK - URBAN LOFT
- MOON OAK - HOME BATHROOM
- DEEP OAK - CONCEPT STORE
- AMBER OAK - HOTEL LOUNGE
- BRIGHT OAK - LUXURY HOTEL
- BRIGHT OAK - JUNIOR SUITE

SURFACE RANGE & TECHNICAL SPECS



ENJOY THE VIDEO



AMBER OAK



Log Amber Oak Forest
20x120 cm | 7⁷/₈"x47¹/₄"



Image gallery

INDEX



INSPIRATION



IMAGE GALLERY



- ICON OAK - RESIDENTIAL VILLA IN&OUT
- ICON OAK - URBAN LOFT
- MOON OAK - HOME BATHROOM
- DEEP OAK - CONCEPT STORE
- AMBER OAK - HOTEL LOUNGE
- BRIGHT OAK - LUXURY HOTEL
- BRIGHT OAK - JUNIOR SUITE

SURFACE RANGE & TECHNICAL SPECS



ENJOY THE VIDEO





FLOOR

Log
 Amber Oak Forest
 Matte Sensitech
 20x180 cm | 7⁷/₈"x70⁷/₈"

WALL

Log
 Amber Oak Forest
 Matte Sensitech
 20x180 cm | 7⁷/₈"x70⁷/₈"

Log
 Icon Oak Modern Frame 2
 Matte Sensitech
 60x60 cm | 23⁵/₈"x23⁵/₈"

FURNITURE

Atlas Plan
 Negresco
 Silk
 162x324 cm | 63³/₄"x127¹/₂"

INDEX



INSPIRATION



IMAGE GALLERY



- ICON OAK - RESIDENTIAL VILLA IN&OUT
- ICON OAK - URBAN LOFT
- MOON OAK - HOME BATHROOM
- DEEP OAK - CONCEPT STORE
- AMBER OAK - HOTEL LOUNGE
- BRIGHT OAK - LUXURY HOTEL
- BRIGHT OAK - JUNIOR SUITE

SURFACE RANGE & TECHNICAL SPECS



ENJOY THE VIDEO





FLOOR
Log
 Amber Oak Forest
 Matte Sensitech
 20x180 cm | 7⁷/₈"x70⁷/₈"

WALL
Log
 Amber Oak Forest
 Matte Sensitech
 20x180 cm | 7⁷/₈"x70⁷/₈"

Log
 Icon Oak Modern Frame 2
 Matte Sensitech
 60x60 cm | 23⁵/₈"x23⁵/₈"

FURNITURE
Atlas Plan
 Negresco
 Silk
 162x324 cm | 63³/₄"x127¹/₂"

INDEX



INSPIRATION



IMAGE GALLERY



ICON OAK
 RESIDENTIAL VILLA IN&OUT
 ICON OAK - URBAN LOFT
 MOON OAK - HOME BATHROOM
 DEEP OAK - CONCEPT STORE
 AMBER OAK - HOTEL LOUNGE
 BRIGHT OAK - LUXURY HOTEL
 BRIGHT OAK - JUNIOR SUITE

SURFACE RANGE & TECHNICAL SPECS



ENJOY THE VIDEO





FLOOR
Log
Amber Oak Forest
 Matte Sensitech
 20x180 cm | 7⁷/₈"x70⁷/₈"

INDEX 





INSPIRATION 

IMAGE GALLERY 

- ICON OAK
- RESIDENTIAL VILLA IN&OUT
- ICON OAK - URBAN LOFT
- MOON OAK - HOME BATHROOM
- DEEP OAK - CONCEPT STORE
- AMBER OAK - HOTEL LOUNGE**
- BRIGHT OAK - LUXURY HOTEL
- BRIGHT OAK - JUNIOR SUITE

SURFACE RANGE & TECHNICAL SPECS 

ENJOY THE VIDEO 

BRIGHT OAK



Log Bright Oak Forest
20x120 cm | 7 7/8" x 4 7/4"



INDEX



INSPIRATION



IMAGE GALLERY



- ICON OAK - RESIDENTIAL VILLA IN&OUT
- ICON OAK - URBAN LOFT
- MOON OAK - HOME BATHROOM
- DEEP OAK - CONCEPT STORE
- AMBER OAK - HOTEL LOUNGE
- BRIGHT OAK - LUXURY HOTEL
- BRIGHT OAK - JUNIOR SUITE

SURFACE RANGE & TECHNICAL SPECS



ENJOY THE VIDEO





OUTDOOR FLOOR
Log
Bright Oak Forest
 Outdoor Sensitech ± 20mm
 30x120 cm | 11³/₄"x47¹/₄"

Log
Bright Oak Forest
 Elemento L Outdoor Sensitech ± 20mm
 30x120 cm | 11³/₄"x47¹/₄"

INDEX



INSPIRATION



IMAGE GALLERY



- ICON OAK
- RESIDENTIAL VILLA IN&OUT
- ICON OAK - URBAN LOFT
- MOON OAK - HOME BATHROOM
- DEEP OAK - CONCEPT STORE
- AMBER OAK - HOTEL LOUNGE
- BRIGHT OAK - LUXURY HOTEL
- BRIGHT OAK - JUNIOR SUITE

SURFACE RANGE & TECHNICAL SPECS



ENJOY THE VIDEO





INDOOR FLOOR

Log
Bright Oak
 Matte Sensitech
 20x120 cm | 7⁷/₈"x47¹/₄"

OUTDOOR FLOOR

Log
Bright Oak Forest
 Outdoor Sensitech \pm 20mm
 30x120 cm | 11³/₄"x47¹/₄"

Log
Bright Oak Forest
 Elemento L Outdoor Sensitech \pm 20mm
 30x120 cm | 11³/₄"x47¹/₄"



INDEX



INSPIRATION



IMAGE GALLERY



- ICON OAK
- RESIDENTIAL VILLA IN&OUT
- ICON OAK - URBAN LOFT
- MOON OAK - HOME BATHROOM
- DEEP OAK - CONCEPT STORE
- AMBER OAK - HOTEL LOUNGE
- BRIGHT OAK - LUXURY HOTEL
- BRIGHT OAK - JUNIOR SUITE

SURFACE RANGE & TECHNICAL SPECS



ENJOY THE VIDEO





^ INDOOR FLOOR **Log Bright Oak**
 Matte Sensitech
 20x120 cm | 7⁷/₈"x47¹/₄"

> OUTDOOR FLOOR **Log Bright Oak Deck**
 Outdoor Sensitech 20mm
 60x120 cm | 23⁵/₈"x47¹/₄"



INDEX 



INSPIRATION 

IMAGE GALLERY 

- ICON OAK
- RESIDENTIAL VILLA IN&OUT
- ICON OAK - URBAN LOFT
- MOON OAK - HOME BATHROOM
- DEEP OAK - CONCEPT STORE
- AMBER OAK - HOTEL LOUNGE
- BRIGHT OAK - LUXURY HOTEL
- BRIGHT OAK - JUNIOR SUITE

SURFACE RANGE & TECHNICAL SPECS 

ENJOY THE VIDEO 



INDOOR FLOOR
Log
 Bright Oak Forest
 Grip Sensitech
 20x120 cm | 7⁷/₈"x47¹/₄"

Log
 Bright Oak Forest
 Elemento L Grip Sensitech
 20x120 cm | 7⁷/₈"x47¹/₄"

OUTDOOR FLOOR
Log
 Bright Oak Forest
 Outdoor Sensitech ⚡ 20mm
 30x120 cm | 11³/₄"x47¹/₄"

INDEX



INSPIRATION



IMAGE GALLERY



- ICON OAK - RESIDENTIAL VILLA IN&OUT
- ICON OAK - URBAN LOFT
- MOON OAK - HOME BATHROOM
- DEEP OAK - CONCEPT STORE
- AMBER OAK - HOTEL LOUNGE
- BRIGHT OAK - LUXURY HOTEL
- BRIGHT OAK - JUNIOR SUITE

SURFACE RANGE & TECHNICAL SPECS



ENJOY THE VIDEO





FLOOR

Log
Bright Oak Forest
Matte Sensitech
20x120 cm | 7⁷/₈"x47¹/₄"

WALL

Log
Bright Oak 3D Tatami
Matte Sensitech
20x120 cm | 7⁷/₈"x47¹/₄"

Boost Natural
Kaolin
Matte
120x278 cm | 47¹/₄"x109¹/₂"

TOP | LEVEL

Atlas Concorde Habitat
Log Bright Oak
Matte
190x50x15 cm | 74³/₄"x19⁵/₈"x5⁷/₈"

SHELF | ESSENZA - THIN

Atlas Concorde Habitat
Log Bright Oak
Matte
190x35x5 cm | 74³/₄"x13³/₄"x2"

INDEX



INSPIRATION



IMAGE GALLERY



ICON OAK
RESIDENTIAL VILLA IN&OUT
ICON OAK - URBAN LOFT
MOON OAK - HOME BATHROOM
DEEP OAK - CONCEPT STORE
AMBER OAK - HOTEL LOUNGE
BRIGHT OAK - LUXURY HOTEL
BRIGHT OAK - JUNIOR SUITE

SURFACE RANGE & TECHNICAL SPECS



ENJOY THE VIDEO





^
FLOOR
Log
Bright Oak Forest
 Matte Sensitech
 20x120 cm | 7⁷/₈"x47¹/₄"

WALL
Log
Bright Oak 3D Pleat
 Matte Sensitech
 50x120 cm | 19⁵/₈"x47¹/₄"

Boost Natural
Kaolin
 Matte
 120x278 cm | 47¹/₄"x109¹/₂"

SIDE TABLE | CONTATTO
Atlas Concorde Habitat
Precious Brown
 Silk
 ø 45 cm | 17³/₄"

>
FLOOR
Log
Bright Oak Forest
 Matte Sensitech
 20x120 cm | 7⁷/₈"x47¹/₄"

WALL
Boost Natural
Kaolin
 Matte
 120x278 cm | 47¹/₄"x109¹/₂"

TOP | LEVEL
Atlas Concorde Habitat
Log Bright Oak
 Matte
 190x50x15 cm | 74³/₄"x19⁵/₈"x5⁷/₈"

SHELF | ESSENZA - THIN
Atlas Concorde Habitat
Log Bright Oak
 Matte
 190x35x5 cm | 74³/₄"x13³/₄"x2"



INDEX



INSPIRATION



IMAGE GALLERY



ICON OAK - RESIDENTIAL VILLA IN&OUT
 ICON OAK - URBAN LOFT
 MOON OAK - HOME BATHROOM
 DEEP OAK - CONCEPT STORE
 AMBER OAK - HOTEL LOUNGE
 BRIGHT OAK - LUXURY HOTEL
 BRIGHT OAK - JUNIOR SUITE

SURFACE RANGE & TECHNICAL SPECS



ENJOY THE VIDEO



SURFACE RANGE & TECHNICAL SPECIFICATIONS

◊
LOG RANGE

◊
TECHNICAL SPECIFICATIONS

◊
LOG WORLD

◊
SENSITECH TECHNOLOGY

INDEX



INSPIRATION



IMAGE
GALLERY



**SURFACE
RANGE &
TECHNICAL
SPECS**



LOG RANGE
TECHNICAL SPECIFICATIONS
LOG WORLD
SENSITECH TECHNOLOGY

ENJOY
THE VIDEO



Porcelain tiles

PORCELAIN TILES - Gres Porcellanato - Grès cérame - Feinsteinzeug - Gres porcelánico - Керамический гранит

RECTIFIED MONOCALIBER - Rettificato monocalibro - Rectifié mono-calibre - Geschliffen einkalibrig - Rectificado monocalibre - Ретифицированный в одном калибре

NATURAL SELECTION

Floor Wall

		Bright Oak	Icon Oak	Amber Oak	Deep Oak	Moon Oak
120x278 cm - 47 ¹ / ₄ "x109 ¹ / ₂ " - ID Skin	± 6 mm	Matte	Matte			
20x180 cm - 7 ¹ / ₈ "x70 ¹ / ₈ " - ID Skin	± 9,5 mm	Matte Sensitech	Matte Sensitech	Matte Sensitech	Matte Sensitech	Matte Sensitech
20x120 cm - 7 ¹ / ₈ "x47 ¹ / ₄ " - ID Skin	± 9 mm	Matte Sensitech	Matte Sensitech	Matte Sensitech	Matte Sensitech	Matte Sensitech
18,5x150 cm - 7 ¹ / ₄ "x59"	± 9 mm	Matte Sensitech	Matte Sensitech	Matte Sensitech	Matte Sensitech	Matte Sensitech

Outdoor

60x120 cm - 23 ⁵ / ₈ "x47 ¹ / ₄ " Deck	± 20 mm	Outdoor Sensitech	Outdoor Sensitech			
--	---------	-------------------	-------------------	--	--	--

FOREST SELECTION

Floor Wall

		Bright Oak Forest	Icon Oak Forest	Amber Oak Forest	Deep Oak Forest	Moon Oak Forest
20x180 cm - 7 ¹ / ₈ "x70 ¹ / ₈ " - ID Skin	± 9,5 mm	Matte Sensitech	Matte Sensitech	Matte Sensitech	Matte Sensitech	Matte Sensitech
20x120 cm - 7 ¹ / ₈ "x47 ¹ / ₄ " - ID Skin	± 9 mm	Matte Sensitech	Matte Sensitech	Matte Sensitech	Matte Sensitech	Matte Sensitech
18,5x150 cm - 7 ¹ / ₄ "x59"	± 9 mm	Matte Sensitech	Matte Sensitech	Matte Sensitech	Matte Sensitech	Matte Sensitech

Outdoor

20x120 cm - 47 ¹ / ₄ "x47 ¹ / ₄ " - ID Skin	± 9 mm	Grip Sensitech	Grip Sensitech	Grip Sensitech	Grip Sensitech	Grip Sensitech
30x120 cm - 11 ³ / ₄ "x47 ¹ / ₄ "	± 20 mm	Outdoor Sensitech	Outdoor Sensitech	Outdoor Sensitech	Outdoor Sensitech	Outdoor Sensitech

Sensitech pag.106

Wall tiles

WALL TILES - Rivestimenti - Revêtements - Wandfliesen - Revestimientos - Настенная плитка

RECTIFIED MONOCALIBER - Rettificato monocalibro - Rectifié mono-calibre - Geschliffen einkalibrig - Rectificado monocalibre - Ретифицированный в одном калибре

Wall

		Bright Oak	Icon Oak	Amber Oak	Deep Oak	Moon Oak
50x120 cm - 19 ⁵ / ₈ "x47 ¹ / ₄ " 3D Pleat	± 8,5 mm	Matte	Matte	Matte	Matte	Matte

Destination of use



Matte ± 6 mm



Matte Sensitech ± 9-9,5 mm
Grip Sensitech ± 9 mm
Outdoor Sensitech ± 20 mm

Anti-slip



R9 A Matte ± 6 mm
R10 A+B Matte Sensitech ± 9-9,5 mm
R11 C Grip Sensitech ± 9 mm
R11 C Outdoor Sensitech ± 20 mm

Color-shading

V2 Slight Variation
Natural Selection all colors
V3 Moderate Variation
Forest Selection all colors

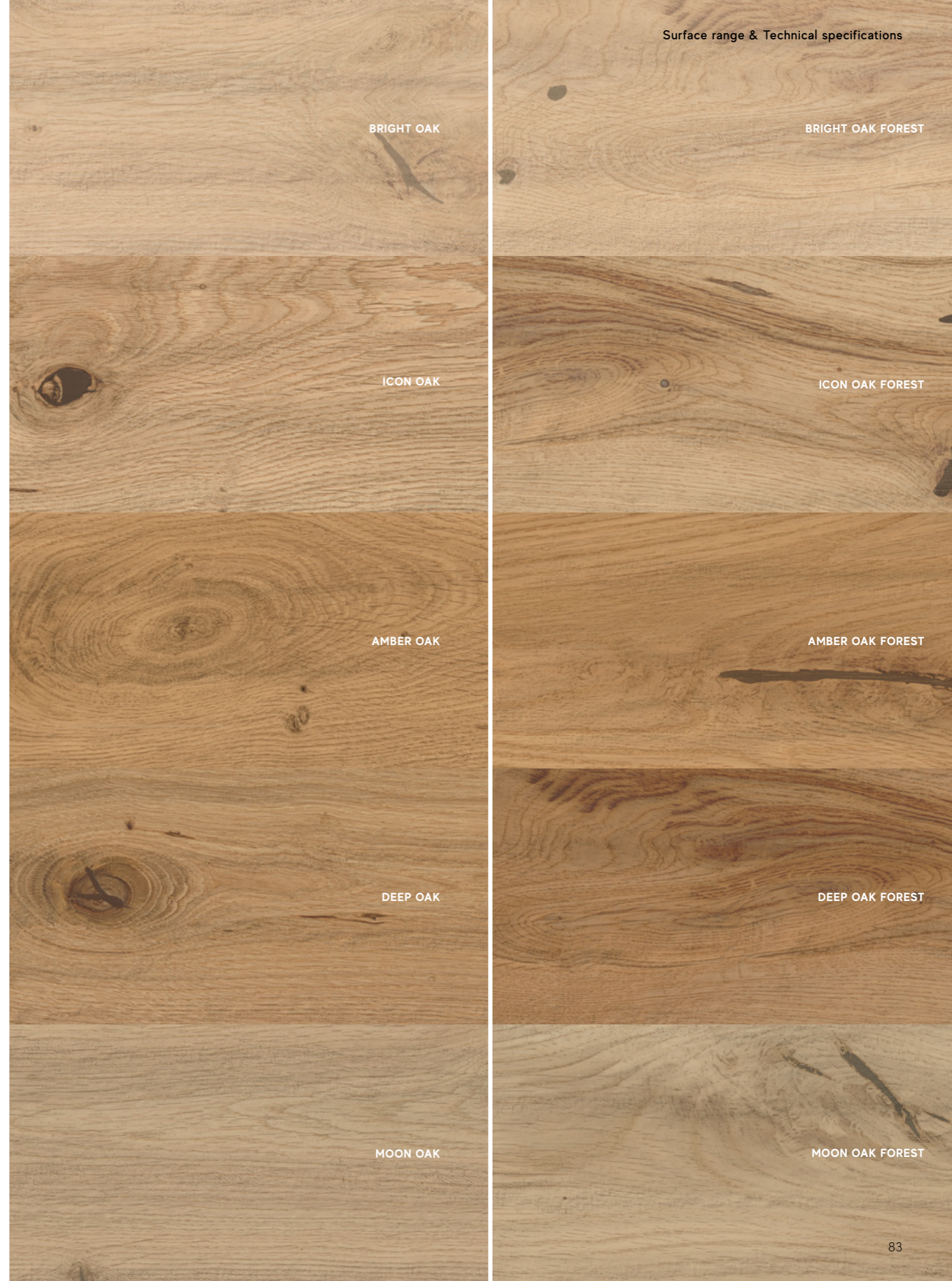

INDEX



INSPIRATION



IMAGE GALLERY



SURFACE RANGE & TECHNICAL SPECS

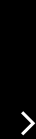

LOG RANGE
TECHNICAL SPECIFICATIONS
LOG WORLD
SENSITECH TECHNOLOGY

ENJOY THE VIDEO



Bright Oak

Natural

PORCELAIN TILES - Gres Porcellanato - Grès cérame - Feinsteinzeug - Gres porcelánico - Керамический гранит
RECTIFIED MONOCALIBER - Rettificato monocalibro - Rectifié mono-calibre - Geschliffen einkalibrig - Rectificado monocalibre - Ретифицированный в одном калибре

Indoor

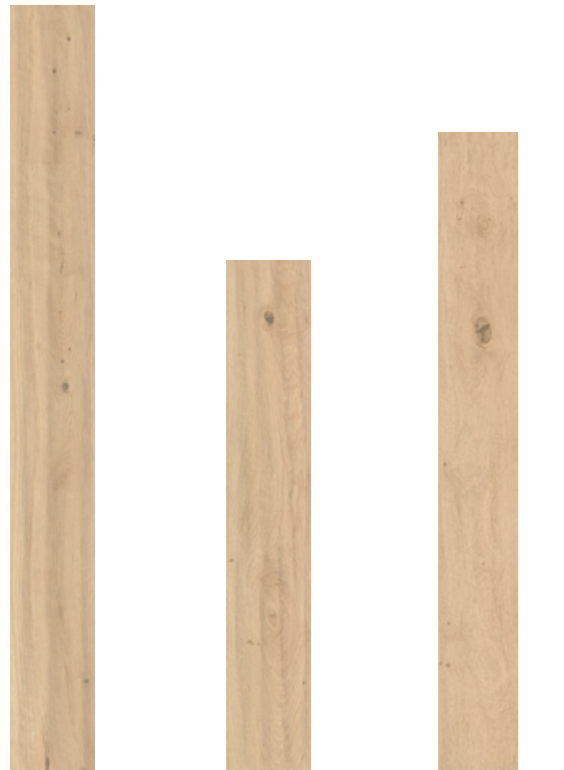

20x180 cm
7¹/₈"x70¹/₈"
Matte Sensitech
± 9,5 mm

20x120 cm
7¹/₈"x47¹/₄"
Matte Sensitech
± 9 mm

18,5x150 cm
7¹/₄"x59"
Matte Sensitech
± 9 mm

Outdoor

Deck ♦



60x120 cm
23⁵/₈"x47¹/₄"
Outdoor Sensitech
± 20 mm

♦ Graphic pattern. Misalignments in the continuity between different patterns is normal for this type of product. Decoro grafico. Eventuali disallineamenti nella continuità tra grafiche diverse sono una caratteristica intrinseca di questa tipologia di prodotto.



V2 Slight Variation

V3 Moderate Variation



Indoor



20x180 cm
7¹/₈"x70¹/₈"
Matte Sensitech
± 9,5 mm

20x120 cm
7¹/₈"x47¹/₄"
Matte Sensitech
± 9 mm

18,5x150 cm
7¹/₄"x59"
Matte Sensitech
± 9 mm

Outdoor



30x120 cm
11³/₄"x47¹/₄"
Outdoor Sensitech
± 20 mm

20x120 cm
7¹/₈"x47¹/₄"
Grip Sensitech
± 9 mm

Forest

INDEX



INSPIRATION



IMAGE GALLERY



SURFACE RANGE & TECHNICAL SPECS



LOG RANGE
TECHNICAL SPECIFICATIONS
LOG WORLD
SENSITECH TECHNOLOGY

ENJOY THE VIDEO



Icon Oak

Natural

PORCELAIN TILES - Gres Porcellanato - Grès cérame - Feinsteinzeug - Gres porcelánico - Керамический гранит
RECTIFIED MONOCALIBER - Rettificato monocalibro - Rectifié mono-calibre - Geschliffen einkalibrig - Rectificado monocalibre - Ретифицированный в одном калибре

Indoor



20x180 cm
7¹/₈"x70¹/₈"
Matte Sensitech
± 9,5 mm

20x120 cm
7¹/₈"x47¹/₄"
Matte Sensitech
± 9 mm

18,5x150 cm
7¹/₄"x59"
Matte Sensitech
± 9 mm

Outdoor

Deck ♦

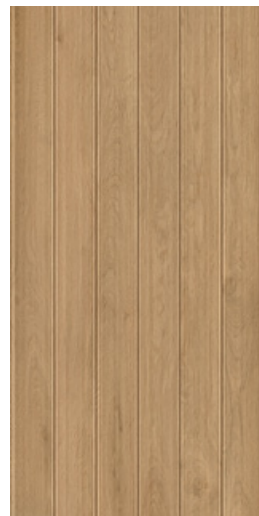

60x120 cm
23⁵/₈"x47¹/₄"
Outdoor Sensitech
± 20 mm

♦ Graphic pattern. Misalignments in the continuity between different patterns is normal for this type of product. Decoro grafico. Eventuali disallineamenti nella continuità tra grafiche diverse sono una caratteristica intrinseca di questa tipologia di prodotto.



V2 Slight Variation

V3 Moderate Variation



Indoor



20x180 cm
7¹/₈"x70¹/₈"
Matte Sensitech
± 9,5 mm

20x120 cm
7¹/₈"x47¹/₄"
Matte Sensitech
± 9 mm

18,5x150 cm
7¹/₄"x59"
Matte Sensitech
± 9 mm

Outdoor



30x120 cm
11³/₄"x47¹/₄"
Outdoor Sensitech
± 20 mm

20x120 cm
7¹/₈"x47¹/₄"
Grip Sensitech
± 9 mm

Forest

INDEX



INSPIRATION



IMAGE GALLERY



SURFACE RANGE & TECHNICAL SPECS

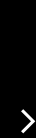

LOG RANGE
TECHNICAL SPECIFICATIONS
LOG WORLD
SENSITECH TECHNOLOGY

ENJOY THE VIDEO



Amber Oak

Natural

Forest

PORCELAIN TILES - Gres Porcellanato - Grès cérame - Feinsteinzeug - Gres porcelánico - Керамический гранит
RECTIFIED MONOCALIBER - Rettificato monocalibro - Rectifié mono-calibre - Geschliffen einkalibrig - Rectificado monocalibre - Ретифицированный в одном калибре

Indoor

V2 Slight Variation



20x180 cm
7⁷/₈"x70⁷/₈"
Matte Sensitech
± 9,5 mm

20x120 cm
7⁷/₈"x47¹/₄"
Matte Sensitech
± 9 mm

18,5x150 cm
7¹/₄"x59"
Matte Sensitech
± 9 mm



V3 Moderate Variation



Indoor



20x180 cm
7⁷/₈"x70⁷/₈"
Matte Sensitech
± 9,5 mm

20x120 cm
7⁷/₈"x47¹/₄"
Matte Sensitech
± 9 mm

18,5x150 cm
7¹/₄"x59"
Matte Sensitech
± 9 mm

Outdoor



30x120 cm
11³/₄"x47¹/₄"
Outdoor Sensitech
± 20 mm

20x120 cm
7⁷/₈"x47¹/₄"
Grip Sensitech
± 9 mm

INDEX



INSPIRATION



IMAGE GALLERY



SURFACE RANGE & TECHNICAL SPECS

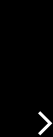

LOG RANGE
TECHNICAL SPECIFICATIONS
LOG WORLD
SENSITECH TECHNOLOGY

ENJOY THE VIDEO



Deep Oak

Natural

Forest

PORCELAIN TILES - Gres Porcellanato - Grès cérame - Feinsteinzeug - Gres porcelánico - Керамический гранит
RECTIFIED MONOCALIBER - Rettificato monocalibro - Rectifié mono-calibre - Geschliffen einkalibrig - Rectificado monocalibre - Ретифицированный в одном калибре

Indoor

V2 Slight Variation



20x180 cm
7⁷/₈"x70⁷/₈"
Matte Sensitech
± 9,5 mm

20x120 cm
7⁷/₈"x47¹/₄"
Matte Sensitech
± 9 mm

18,5x150 cm
7¹/₄"x59"
Matte Sensitech
± 9 mm



V3 Moderate Variation



Indoor



20x180 cm
7⁷/₈"x70⁷/₈"
Matte Sensitech
± 9,5 mm

20x120 cm
7⁷/₈"x47¹/₄"
Matte Sensitech
± 9 mm

18,5x150 cm
7¹/₄"x59"
Matte Sensitech
± 9 mm

Outdoor



30x120 cm
11³/₄"x47¹/₄"
Outdoor Sensitech
± 20 mm

20x120 cm
7⁷/₈"x47¹/₄"
Grip Sensitech
± 9 mm

INDEX



INSPIRATION



IMAGE GALLERY



SURFACE RANGE & TECHNICAL SPECS

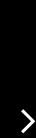

LOG RANGE
TECHNICAL SPECIFICATIONS
LOG WORLD
SENSITECH TECHNOLOGY

ENJOY THE VIDEO



Moon Oak

Natural

Forest

PORCELAIN TILES - Gres Porcellanato - Grès cérame - Feinsteinzeug - Gres porcelánico - Керамический гранит
RECTIFIED MONOCALIBER - Rettificato monocalibro - Rectifié mono-calibre - Geschliffen einkalibrig - Rectificado monocalibre - Ретифицированный в одном калибре

Indoor



Indoor



Outdoor



INDEX



INSPIRATION



IMAGE GALLERY



SURFACE RANGE & TECHNICAL SPECS

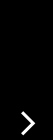

LOG RANGE
TECHNICAL SPECIFICATIONS
LOG WORLD
SENSITECH TECHNOLOGY

ENJOY THE VIDEO



Big Slabs

V3 Moderate Variation
All colors

PORCELAIN TILES - Gres Porcellanato - Grès cérame - Feinsteinzeug - Gres porcelánico - Керамический гранит
RECTIFIED MONOCALIBER - Rettificato monocalibro - Rectifié mono-calibre - Geschliffen einkalibrig - Rectificado monocalibre - Ретифицированный в одном калибре

Line •



Log Bright Oak
Matte
120x278 cm - 47¹/₄"x109¹/₂"
± 6 mm

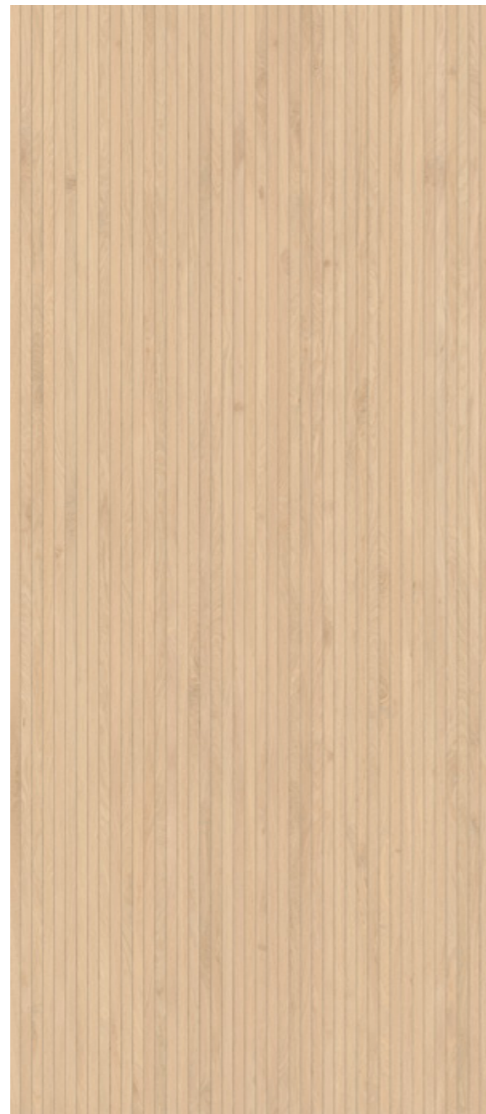

Log Line Bright Oak
Matte
120x278 cm - 47¹/₄"x109¹/₂"
± 6 mm

Line •



Log Icon Oak
Matte
120x278 cm - 47¹/₄"x109¹/₂"
± 6 mm



Log Line Icon Oak
Matte
120x278 cm - 47¹/₄"x109¹/₂"
± 6 mm

♦ Graphic pattern. Misalignments in the continuity between different patterns is normal for this type of product.
Decoro grafico. Eventuali disallineamenti nella continuità tra grafiche diverse sono una caratteristica intrinseca di questa tipologia di prodotto.

INDEX



INSPIRATION



IMAGE
GALLERY



SURFACE
RANGE &
TECHNICAL
SPECS

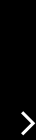

LOG RANGE
TECHNICAL SPECIFICATIONS
LOG WORLD
SENSTECH TECHNOLOGY

ENJOY
THE VIDEO



Frame Decor

V3 Moderate Variation
All colors

PORCELAIN TILES - Gres Porcellanato - Grès cérame - Feinsteinzeug - Gres porcelánico - Керамический гранит
RECTIFIED MONOCALIBER - Rettificato monocalibro - Rectifié mono-calibre - Geschliffen einkalibrig - Rectificado monocalibre - Ретифицированный в одном калибре



Log Classic Frame Icon Oak ♦
Matte Sensitech
120x120 cm - 47 1/4" x 47 1/4"

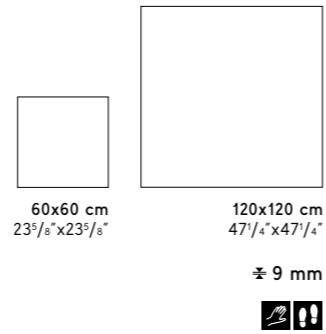

Log Modern Frame 1 Icon Oak ♦
Matte Sensitech
120x120 cm - 47 1/4" x 47 1/4"



Log Modern Frame 2 Icon Oak ♦
Matte Sensitech
60x60 cm - 23 5/8" x 23 5/8"

♦ Graphic pattern. Misalignments in the continuity between different patterns is normal for this type of product.
Decoro grafico. Eventuali disallineamenti nella continuità tra grafiche diverse sono una caratteristica intrinseca di questa tipologia di prodotto.



Chevron Decor

V3 Moderate Variation
All colors

PORCELAIN TILES - Gres Porcellanato - Grès cérame - Feinsteinzeug - Gres porcelánico - Керамический гранит
NON RECTIFIED - Non rettificato - Not rectified - Non rectifié - Nicht rektifiziert - No rectificado - Неретифицированный
ANTISLIP R9A



Log Chevron Bright Oak
Matte
7,5x45 cm - 3" x 17 3/4"



C 7,5 cm - 3"
D 45 cm - 17 3/4"
± 9 mm
[Hand icon] [Warning icon]



Log Chevron Icon Oak
Matte
7,5x45 cm - 3" x 17 3/4"



Log Chevron Amber Oak
Matte
7,5x45 cm - 3" x 17 3/4"



Log Chevron Deep Oak
Matte
7,5x45 cm - 3" x 17 3/4"



Log Chevron Moon Oak
Matte
7,5x45 cm - 3" x 17 3/4"



At least 12 pairs A + B are guaranteed in each box.
All'interno di ciascuna scatola è garantita la presenza di almeno 12 coppie A+B

INDEX



INSPIRATION



IMAGE GALLERY



SURFACE RANGE & TECHNICAL SPECS

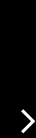

LOG RANGE
TECHNICAL SPECIFICATIONS
LOG WORLD
SENSITECH TECHNOLOGY

ENJOY THE VIDEO



3D Tatami

PORCELAIN TILES - Gres Porcellanato - Grès cérame - Feinsteinzeug - Gres porcelánico - Керамический гранит

V3 Moderate Variation
All colors



Log 3D Tatami Icon Oak
Matte [Sensitech](#)
20x120 cm - 7⁷/₈"x47¹/₄"



Log 3D Tatami Bright Oak
Matte [Sensitech](#)
20x120 cm - 7⁷/₈"x47¹/₄"



Log 3D Tatami Amber Oak
Matte [Sensitech](#)
20x120 cm - 7⁷/₈"x47¹/₄"



Log 3D Tatami Deep Oak
Matte [Sensitech](#)
20x120 cm - 7⁷/₈"x47¹/₄"



Log 3D Tatami Moon Oak
Matte [Sensitech](#)
20x120 cm - 7⁷/₈"x47¹/₄"

Multi-thickness mosaic, close joint installation without grouting.
Mosaico multispessore, posa senza stuccatura a giunto unito.



20x120 cm
7⁷/₈"x47¹/₄"
± 9 mm



3D Pleat

WALL TILES - Rivestimenti - Revêtements - Wandfliesen - Revestimientos - Настенная плитка
RECTIFIED MONOCALIBER - Rettificato monocalibro - Rectifié mono-calibre - Geschliffen einkalibrig - Rectificado monocalibre - Ретицированный в одном калибре

V3 Moderate Variation
All colors



Log 3D Pleat Icon Oak
Matte
50x120 cm - 19⁵/₈"x47¹/₄"



Log 3D Pleat Bright Oak
Matte
50x120 cm - 19⁵/₈"x47¹/₄"



Log 3D Pleat Amber Oak
Matte
50x120 cm - 19⁵/₈"x47¹/₄"

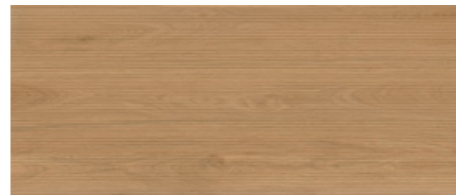

Log 3D Pleat Deep Oak
Matte
50x120 cm - 19⁵/₈"x47¹/₄"



Log 3D Pleat Moon Oak
Matte
50x120 cm - 19⁵/₈"x47¹/₄"



50x120 cm
19⁵/₈"x47¹/₄"
± 8,5 mm



INDEX



INSPIRATION



IMAGE GALLERY



SURFACE RANGE & TECHNICAL SPECS

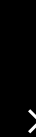

LOG RANGE
TECHNICAL SPECIFICATIONS
LOG WORLD
SENSITECH TECHNOLOGY

ENJOY THE VIDEO



Trim tiles

Porcelain trim tiles

Battiscopa Matte Sensitech

7,2x120 cm - 2⁷/₈"x47¹/₄"
7,2x150 cm - 2⁷/₈"x59"

Scalino Matte Sensitech ✓

33x120 cm - 13"x47¹/₄"
33x150 cm - 13"x59"

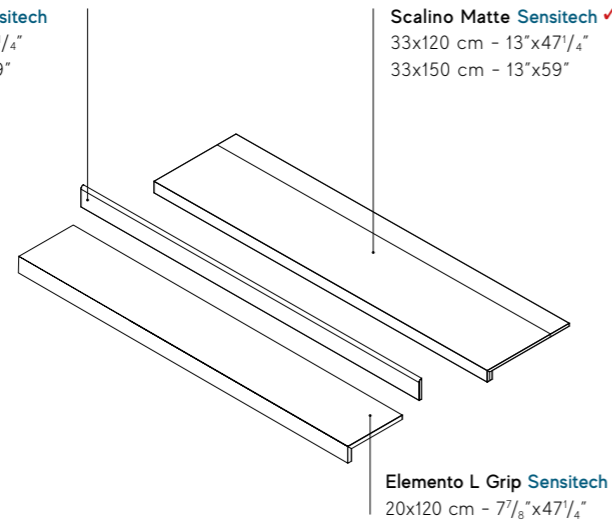

Elemento L Grip Sensitech
20x120 cm - 7⁷/₈"x47¹/₄"

✓ These parts are supplied to order / I pezzi sono disponibili su ordinazione

Wall trim tiles

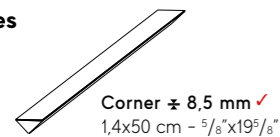

Corner ± 8,5 mm ✓
1,4x50 cm - 5⁵/₈"x19³/₈"

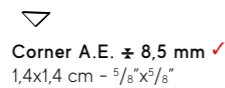

Corner A.E. ± 8,5 mm ✓
1,4x1,4 cm - 5⁵/₈"x5⁵/₈"

✓ These parts are supplied to order / I pezzi sono disponibili su ordinazione

Outdoor trim tiles ± 20 mm



Round
Outdoor Sensitech SP * ♦ ✓
30x120 cm - 11³/₄"x47¹/₄"

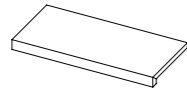

Elemento L
Outdoor Sensitech SP * ✓
30x120 cm - 11³/₄"x47¹/₄"



Alzata
Outdoor Sensitech SP * ✓
20x120 cm - 7⁷/₈"x47¹/₄"

* Available in / Disponibile in Icon Oak Forest, Bright Oak Forest, Amber Oak Forest, Deep Oak Forest, Moon Oak Forest

✓ These parts are supplied to order / I pezzi sono disponibili su ordinazione

♦ Right-left angular elements are available / Sono disponibili gli elementi angolari dx/sx

Outdoor Porcelain tiles ± 20 mm

For further details on the 20mm thick products, related trim pieces and installation systems - in particular for recommendations and precautions during installation- please refer to the Outdoor Design section on the Atlas Concorde website or to the Outdoor Design catalogue. Per dettagli sul prodotto e sui relativi pezzi speciali in 20mm di spessore, per i sistemi di posa e, in particolare, per raccomandazioni, accorgimenti e precauzioni in fase di posa e progettazione, si raccomanda di prendere visione del catalogo Outdoor Design e della sezione Outdoor Design del sito Atlas Concorde.

Laying tips

Stagger the planks at a maximum of 40 cm. It's best to stagger the tiles randomly (see the illustration).

Consigli per la posa. Sfalsare i listoni di 40 cm al massimo. Si consiglia di sfalsare le piastrelle in maniera irregolare. (vedi figura).

Conseils pour la pose. Décaler les listels de 40 cm maximum. Nous conseillons de décaler les carreaux de manière irrégulière. (voir la figure).

Tipps für die Verlegung. Die Dielen maximal um 40 cm versetzt verlegen. Es empfiehlt sich, die Fliesen in unregelmäßig versetztem Verband zu verlegen (siehe Abbildung).

Recomendaciones para la instalación. Escalonar los listones un máximo de 40 cm. Se recomienda escalonar los azulejos de forma irregular (véase figura).

Рекомендации по укладке. Рекомендуется укладывать плитку со смещением не более 40 см. Кроме того, желательно смещать плитки неравномерно (см. рисунок).

Recommended laying patten - Schema di posa consigliato

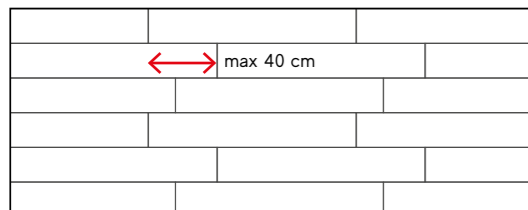

Not recommended laying patten - Schema di posa scongiato

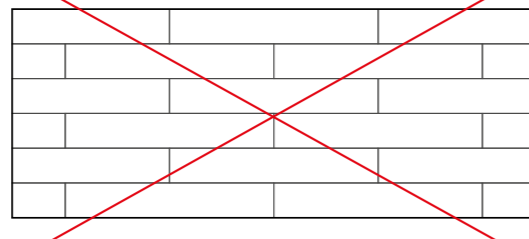

THANKS TO

ITLAS

itlas.com

Note

For information and details relating to codes, packaging and weight it is recommended to refer to the latest pricelist. - Per le informazioni e i dati relativi a codici, imballaggi e pesi occorre sempre consultare l'ultimo listino aggiornato e in vigore. - Pour toutes informations et renseignements concernant les codes, les emballages et les poids, il y a toujours lieu de consulter le dernier tarif en vigueur et mis à jour. - Für Informationen und Daten die den Code, die Verpackung und das Gewicht betreffen bitte die aktuellste Preisliste zugrunde legen. - Para acceder a la información y a los datos relativos a códigos, embalajes y pesos hay que consultar siempre la última lista de precios actualizada y vigente. - Для информации о кодах, упаковках и весе обращайтесь к последнему действующему прайс-листу.

Colors and optical features of the materials illustrated in this catalogue are to be regarded as mere indications. - I colori e le caratteristiche estetiche dei materiali illustrati nel presente catalogo sono da ritenersi puramente indicativi. - Les coloris et les caractéristiques esthétiques des références illustrées dans le catalogue sont donnés à titre purement indicatif. - Die Farben und die ästhetischen Eigenschaften der in diesem Katalog abgebildeten Produkte sind als reine Richtwerte zu betrachten. - Los colores y las características estéticas de los materiales ilustrados en el presente catálogo deben ser considerados como puramente indicativos. - Цвета и эстетические характеристики описанных в настоящем каталоге материалов являются только ориентировочными.

Atlas Concorde reserves the right to modify any product without notice and will not be liable for any direct or indirect damage resulting from such modifications. - Atlas Concorde si riserva di modificare i prodotti senza preavviso, declinando ogni responsabilità su eventuali danni diretti o indiretti derivanti da eventuali modifiche. - Atlas Concorde se réserve le droit de modifier ses produits sans préavis et décline toute responsabilité concernant les éventuels dommages directs ou indirects qui pourraient dériver de ces modifications. - Atlas Concorde behält sich das Recht vor jederzeit und ohne vorherige Ankündigung, die Produkte zu verändern, und lehnt jede Haftung bei direkten oder indirekten Schäden ab, die von diesen Veränderungen herrühren. - Atlas Concorde se reserva el derecho de modificar los productos sin previo aviso, rechaza cualquier responsabilidad sobre eventuales daños directos o indirectos derivados de eventuales modificaciones. - Atlas Concorde оставляет за собой право изменять характеристики изделий без предварительного уведомления, отклоняя при этом любую ответственность за прямые или косвенные убытки, возникшие в результате изменений.

INDEX



INSPIRATION



IMAGE
GALLERY



SURFACE
RANGE &
TECHNICAL
SPECS



LOG RANGE
TECHNICAL SPECIFICATIONS
LOG WORLD
SENSITECH TECHNOLOGY

ENJOY
THE VIDEO





Porcelain tiles - Rectified monocaliber

Gres porcellanato - Rettificato monocalibro

Compliant with standards EN 14411 annex G group B1a
 Compliant with standards ISO 13006 annex G group B1a
 Conforme alla norma EN 14411 Appendice G gruppo B1a
 Conforme alla norma ISO 13006 Appendice G gruppo B1a

120x278 cm - 47 1/8" x 109 1/2"	6 mm	30x120 cm - 11 1/8" x 47 1/8"	20 mm
20x180 cm - 7 7/8" x 70 7/8"	9,5 mm	60x120 cm - 23 3/8" x 47 1/8"	20 mm
20x120 cm - 7 7/8" x 47 1/8"	9 mm		
18,5x150 cm - 7 1/4" x 59"	9 mm		
60x60 cm - 23 3/8" x 23 3/8"	9 mm		
120x120 cm - 47 1/8" x 47 1/8"	9 mm		

Technical features Caratteristiche tecniche	Test Method Metodo di prova	Requirements for nominal size N / Requisiti per dimensione nominale N			Porcelain tiles			
		7 cm ≤ N < 15 cm (mm)	(%)	N ≥ 15 cm (mm)	Matte ± 6 mm	Matte Sensitech ± 9-9,5 mm	Grip Sensitech ± 9 mm	Outdoor Sensitech ± 20 mm
Length and width Lunghezza e larghezza	ISO 10545-2	± 0,9 (*) Non-rect. ± 0,4 (*) Rect.	± 0,6 (*) Non-rect. ± 0,3 (*) Rect.	± 2,0 (*) Non-rect. ± 1,0 (*) Rect.	Suitable for Conforme	Suitable for Conforme	Suitable for Conforme	Suitable for Conforme
Thickness Spessore		± 0,5 (**)	± 5 (***)	± 0,5 (***)	Suitable for Conforme	Suitable for Conforme	Suitable for Conforme	Suitable for Conforme
Straightness of sides Rettilineità degli spigoli		± 0,8 (***) Non-rect. ± 0,4 (***) Rect.	± 0,5 (***) Non-rect. ± 0,3 (***) Rect.	± 1,5 (***) Non-rect. ± 0,8 (***) Rect.	Suitable for Conforme	Suitable for Conforme	Suitable for Conforme	Suitable for Conforme
Rectangularity (Measurement only on short edges when L/l ≥ 3) Ortogonalità (Misurazione da condurre solo sui lati corti quando L/l ≥ 3)	ISO 10545-2	± 0,8 (****) Non-rect. ± 0,4 (****) Rect.	± 0,5 (****) Non-rect. ± 0,3 (****) Rect.	± 2,0 (****) Non-rect. ± 1,5 (****) Rect.	Suitable for Conforme	Suitable for Conforme	Suitable for Conforme	Suitable for Conforme
Surface flatness Planarità		c.c. ± 0,8 Non-rect. c.c. ± 0,6 Rect. e.c. ± 0,8 Non-rect. e.c. ± 0,6 Rect. w. ± 0,8 Non-rect. w. ± 0,6 Rect.	c.c. ± 0,5 Non-rect. c.c. ± 0,4 Rect. e.c. ± 0,5 Non-rect. e.c. ± 0,4 Rect. w. ± 0,5 Non-rect. w. ± 0,4 Rect.	c.c. ± 2,0 Non-rect. c.c. ± 1,8 Rect. e.c. ± 2,0 Non-rect. e.c. ± 1,8 Rect. w. ± 2,0 Non-rect. w. ± 1,8 Rect.	Suitable for Conforme	Suitable for Conforme	Suitable for Conforme	Suitable for Conforme
Water absorption (in% by mass) Massa d'acqua assorbita (come % della massa)		ISO 10545-3 ASTM C373	E _v ≤ 0,5% Individual Maximum 0,6% E _v ≤ 0,5% Valore massimo singolo 0,6%			≤ 0,1 %	≤ 0,1 %	≤ 0,1 %
Breaking strength Sforzo di rottura	ISO 10545-4	S ≥ 700N (for thickness < 7,5 mm - per spessore < 7,5 mm) S ≥ 1300N (for thickness ≥ 7,5 mm - per spessore ≥ 7,5 mm)			S ≥ 1000 N	S ≥ 1500 N	S ≥ 1500 N	S ≥ 10000 N
Modulus of rupture Resistenza alla flessione	EN 1339 Annex F	R ≥ 35 N/mm ²			R ≥ 40 N/mm ²	R ≥ 40 N/mm ²	R ≥ 40 N/mm ²	R ≥ 45 N/mm ²
Bending strength and breaking load Resistenza a flessione e al carico di rottura (4)/(5)		-			-	-	-	≥ U3 30x120 ≥ U4 60x120
Impact resistance, as coefficient of restitution Resistenza all'impatto, espresso come coefficiente di restituzione	ISO 10545-5	Declared value Valore dichiarato			≥ 0,55	≥ 0,55	≥ 0,55	≥ 0,55
Resistance to deep abrasion of unglazed tiles (removed volume) Resistenza all'abrasione profonda delle piastrelle non smaltate (volume materiale asportato)	ISO 10545-6	≤ 175 mm ³			≤ 150 mm ³	≤ 150 mm ³	≤ 150 mm ³	≤ 150 mm ³
Coefficient of thermal linear expansion Coefficiente di dilatazione termica lineare	ISO 10545-8	Declared value Valore dichiarato			≤ 7MK ⁻¹	≤ 7MK ⁻¹	≤ 7MK ⁻¹	≤ 7MK ⁻¹
Thermal shock resistance Resistenza agli sbalzi termici	ISO 10545-9	Pass according to EN ISO 10545-1 Test superato in accordo con ISO 10545-1			Resistant Resiste	Resistant Resiste	Resistant Resiste	Resistant Resiste
Moisture expansion (in mm/m) Dilatazione all'umidità (in mm/m)	ISO 10545-10	Declared value Valore dichiarato			≤ 0,01% (0,1mm/m)	≤ 0,01% (0,1mm/m)	≤ 0,01% (0,1mm/m)	≤ 0,01% (0,1mm/m)
Frost resistance Resistenza al gelo	ISO 10545-12	Pass according to EN ISO 10545-1 Test superato in accordo con ISO 10545-1			Resistant Resiste	Resistant Resiste	Resistant Resiste	Resistant Resiste
Bond strenght /adhesion for Cementitious Adhesives Adesione mediante trazione su adesivi cementizi	EN 12004-2	Declared value Valore dichiarato			≥ 10 N/mm ² (Class C2 - EN 12004)	≥ 10 N/mm ² (Class C2 - EN 12004)	≥ 10 N/mm ² (Class C2 - EN 12004)	≥ 10 N/mm ² (Class C2 - EN 12004)
Reaction to fire Reazione al fuoco	-	Class A1 or A1 _f Classe A1 oppure A1 _f			A1 - A1 _f	A1 - A1 _f	A1 - A1 _f	A1 - A1 _f
Resistance to household chemicals and swimming pool salts Resistenza ai prodotti chimici di uso domestico e agli additivi per piscina	ISO 10545-13	Minimum Class B Classe minima B			A	A	A	A
Resistance to low concentrations of acids and alkalis Resistenza a basse concentrazioni di acidi e alcali		Declared Class Classe dichiarata			LA	LA	LA	LA
Resistance to high concentrations of acids and alkalis Resistenza ad alte concentrazioni di acidi e alcali		Declared Class Classe dichiarata			HA	HA	HA	HA
Resistance to staining, for unglazed tiles Resistenza alle macchie per piastrelle non smaltate	ISO 10545-14	Declared Class Classe dichiarata			5	5	5	5
Shood Ramp Test Metodo della rampa "calzato"	DIN EN 16165 ANNEX B (EX DIN 51130)	Declared value Valore dichiarato			R9	R10	R11	R11
Barefoot Ramp Test Metodo della rampa a piedi nudi	DIN EN 16165 ANNEX A (EX DIN 51097)	Declared value Valore dichiarato			A	A+B	A+B+C	A+B+C
Pendulum Friction Test Metodo del Pendolo (1)(2)	BS EN 16165 ANNEX C (EX BS 7976)	PTV ≥ 36 classifies the surface as 'low slip risk'			(●)	≥ 36 Dry ≥ 36 Wet	≥ 36 Dry ≥ 36 Wet	≥ 36 Dry ≥ 36 Wet
	AS 4586	Declared Classification of the new pedestrian surface materials according to the Pendulum Test			(●●)	Class P3	Class P4	Class P4
Coefficient of friction (COF) Coefficiente di attrito	UNE EN 16165 ANNEX C (EX UNE 41901 EX 2017)	Declared value Valore dichiarato			(●●●)	Class C2	Class C3	Class C3
	B.C.R.A. Rep. CEC/81	D. M. 236/89 del 14/06/89 μ > 0,40 per elemento scivolante cuoio su pavimentazione asciutta μ > 0,40 per elemento scivolante gomma dura su pavimentazione bagnata			> 0,40 Asciutto > 0,40 Bagnato	> 0,40 Asciutto > 0,40 Bagnato	> 0,40 Asciutto > 0,40 Bagnato	> 0,40 Asciutto > 0,40 Bagnato
Dynamic coefficient of friction (DCOF) Coefficiente di attrito dinamico	ANSI A 326,3	-			dry DCOF ≥ 0,42	wet DCOF ≥ 0,50	wet DCOF ≥ 0,55	wet DCOF ≥ 0,55

(*) The permissible deviation, in % or mm, of the average size for each tile (2 or 4 sides) from work size (WS). Deviazione ammissibile, in % oppure mm, della dimensione media di ogni piastrella (2 oppure 4 lati) dalla dimensione di fabbricazione (WS).
 (**) The permissible deviation, in % or mm, of the average thickness for each tile from the work size thickness (WS). Deviazione ammissibile, in % oppure mm, della spessore medio di ogni piastrella dallo spessore riportato nella dimensione di fabbricazione (WS).
 (***) The maximum permissible deviation from straightness, in % or mm, related to the corresponding work sizes (WS). Deviazione massima ammissibile di rettilineità, in % oppure mm, in rapporto alle dimensioni di fabbricazione (WS) corrispondenti.
 (****) The maximum permissible deviation from rectangularity, in % or mm, related to the corresponding work sizes (WS). Deviazione massima ammissibile di ortogonalità, in % oppure mm, in rapporto alle dimensioni di fabbricazione (WS) corrispondenti.
 c.c. The maximum permissible deviation from centre curvature, in % or mm, related to diagonal calculated from the work sizes (WS). Deviazione massima ammissibile della curvatura del centro, in % oppure mm, in rapporto alla diagonale calcolata secondo le dimensioni di fabbricazione (WS).
 e.c. The maximum permissible deviation from edge curvature, in % or mm, related to the corresponding work sizes (WS). Deviazione massima ammissibile della curvatura dello spigolo, in % oppure mm, in rapporto alle dimensioni di fabbricazione (WS) corrispondenti.
 w. The maximum permissible deviation from warpage, in % or mm, related to diagonal calculated from the work sizes (WS). Deviazione massima ammissibile dello sverglamento, in % oppure mm, in rapporto alla diagonale calcolata secondo le dimensioni di fabbricazione (WS).
 (1) Determination of slip resistance of pedestrian surfaces; it does not cover sports surfaces and road surfaces for vehicles (skid resistance). Determinazione della resistenza allo scivolamento delle superfici pedonabili; non si applica alle pavimentazioni sportive ed alle pavimentazioni stradali veicolari.
 (2) Anti-slip performance is guaranteed at the time of delivery of the product. Le prestazioni anti-slip vengono garantite al momento della consegna del prodotto.
 (A) For further details, please refer to outdoor design general catalogue. Per maggiori informazioni riferirsi al catalogo generale Outdoor Design.
 (B) Only for products with 20 mm thickness. Solo per prodotti a 20mm di spessore.
 (●) PTV ≥ 36 Wet on demand / su richiesta (●●) P3 on demand / su richiesta (●●●) C2 on demand / su richiesta



Wall tiles - Rectified monocaliber

Rivestimento - Rettificato monocalibro

Compliant with standards EN 14411 annex L group B11
 Compliant with standards ISO 13006 annex L group B11
 Conforme alla norma EN 14411 Appendice L gruppo B11
 Conforme alla norma ISO 13006 Appendice L gruppo B11

50x120 cm - 19 3/8" x 47 1/8"	± 8,5 mm
-------------------------------	----------

Technical features Caratteristiche tecniche	Test Method Metodo di prova	Requirements for nominal size N / Requisiti per dimensione nominale N			Wall tiles
		7 cm ≤ N < 15 cm (mm)	(%)	N ≥ 15 cm (mm)	
Length and width Lunghezza e larghezza	ISO 10545-2	± 0,4 (*) Rect.	± 0,3 (*) Rect.	± 1,0 (*) Rect.	Suitable for Conforme
Thickness Spessore		± 0,5 (**)	± 10 (***)	± 0,5 (**)	Suitable for Conforme
Straightness of sides Rettilineità degli spigoli		± 0,4 (****) Rect.	± 0,3 (****) Rect.	± 0,8 (****) Rect.	Suitable for Conforme
Rectangularity (Measurement only on short edges when L/l ≥ 3) Ortogonalità (Misurazione da condurre solo sui lati corti quando L/l ≥ 3)	ISO 10545-2	± 0,4 (****) Rect.	± 0,3 (****) Rect.	± 1,5 (****) Rect.	Suitable for Conforme
Surface flatness Planarità		c.c. ± 0,6 Rect.	c.c. ± 0,4 Rect.	c.c. ± 1,8 Rect.	Non applicable Not applicable
Water absorption (in% by mass) Massa d'acqua assorbita (come % della massa)		e.c. ± 0,6 Rect.	e.c. ± 0,4 Rect.	e.c. ± 1,8 Rect.	
Breaking strength Sforzo di rottura	ISO 10545-4	Average >10%. When the average > 20%, this shall be indicated. Individual value > 9% Media >10%. Se questo valore > 20%, deve essere indicato. Valore Singolo > 9%			10% < E _v ≤ 20%
Modulus of rupture Resistenza alla flessione	ISO 10545-4	S ≥ 600 N			S ≥ 600 N
Impact resistance Resistenza all'impatto		R ≥ 15 N/mm ²			R ≥ 15 N/mm ²
Coefficient of thermal linear expansion Coefficiente di dilatazione termica lineare	ISO 10545-8	Declared value Valore dichiarato			≤ 7MK ⁻¹
Thermal shock resistance Resistenza agli sbalzi termici	ISO 10545-9	Pass according to EN ISO 10545-1 Test superato in accordo con ISO 10545-1			Resistant Resiste
Moisture expansion (in mm/m) Dilatazione all'umidità (in mm/m)	ISO 10545-10	Declared value Valore dichiarato			≤ 0,06% (0,6mm/m)
Crazing resistance Resistenza al cavillo	ISO 10545-11	Pass according to EN ISO 10545-1 Test superato in accordo con ISO 10545-1			Resistant Resiste
Bond strenght /adhesion for Cementitious Adhesives Adesione mediante trazione su adesivi cementizi	EN 12004-2	Declared value Valore dichiarato			≥ 10 N/mm ² (Class C2 - EN 12004)
Reaction to fire Reazione al fuoco	-	Class A1 Classe A1			A1
Resistance to household chemicals and swimming pool salts Resistenza ai prodotti chimici di uso domestico e agli additivi per piscina	ISO 10545-13	Minimum Class B Classe minima B			A
Resistance to low concentrations of acids and alkalis Resistenza a basse concentrazioni di acidi e alcali		Declared Class Classe dichiarata			LA
Resistance to high concentrations of acids and alkalis Resistenza ad alte concentrazioni di acidi e alcali		Declared Class Classe dichiarata			HA
Resistance to staining, for unglazed tiles Resistenza alle macchie per piastrelle non smaltate	ISO 10545-14	Minimum Class 3 Classe 3 minima			5
Release of dangerous substances: Cadmium (in mg/dm²) and Lead (in mg/dm²) Rilascio di sostanze pericolose: Cadmio (in mg/dm ²) e Piombo (in mg/dm ²)	ISO 10545-15	Declared value Valore dichiarato			≤ 0,01 mg/dm ² Cd ≤ 0,1 mg/dm ² Pb

(*) The permissible deviation, in % or mm, of the average size for each tile (2 or 4 sides) from work size (WS). Deviazione ammissibile, in % oppure mm, della dimensione media di ogni piastrella (2 oppure 4 lati) dalla dimensione di fabbricazione (WS).
 (**) The permissible deviation, in % or mm, of the average thickness for each tile from the work size thickness (WS). Deviazione ammissibile, in % oppure mm, della spessore medio di ogni piastrella dallo spessore riportato nella dimensione di fabbricazione (WS).
 (***) The maximum permissible deviation from straightness, in % or mm, related to the corresponding work sizes (WS). Deviazione massima ammissibile di rettilineità, in % oppure mm, in rapporto alle dimensioni di fabbricazione (WS) corrispondenti.
 (****) The maximum permissible deviation from rectangularity, in % or mm, related to the corresponding work sizes (WS). Deviazione massima ammissibile di ortogonalità, in % oppure mm, in rapporto alle dimensioni di fabbricazione (WS) corrispondenti.
 c.c. The maximum permissible deviation from centre curvature, in % or mm, related to diagonal calculated from the work sizes (WS). Deviazione massima ammissibile della curvatura del centro, in % oppure mm, in rapporto alla diagonale calcolata secondo le dimensioni di fabbricazione (WS).
 e.c. The maximum permissible deviation from edge curvature, in % or mm, related to the corresponding work sizes (WS). Deviazione massima ammissibile della curvatura dello spigolo, in % oppure mm, in rapporto alle dimensioni di fabbricazione (WS) corrispondenti.
 w. The maximum permissible deviation from warpage, in % or mm, related to diagonal calculated from the work sizes (WS). Deviazione massima ammissibile dello sverglamento, in % oppure mm, in rapporto alla diagonale calcolata secondo le dimensioni di fabbricazione (WS).

INDEX



INSPIRATION



IMAGE GALLERY



SURFACE RANGE & TECHNICAL SPECS



LOG RANGE TECHNICAL SPECIFICATIONS
 LOG WORLD SENSITECH TECHNOLOGY

ENJOY THE VIDEO



LOGWORLD

LOG LOG
CANSEI



The Atlas Concorde Wood Effect

DISCOVER LOG WORLD



INDEX



INSPIRATION



IMAGE GALLERY



SURFACE RANGE & TECHNICAL SPECS

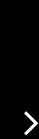

LOG RANGE
TECHNICAL SPECIFICATIONS
LOG WORLD
SENSTECH TECHNOLOGY

ENJOY THE VIDEO



Sensitech

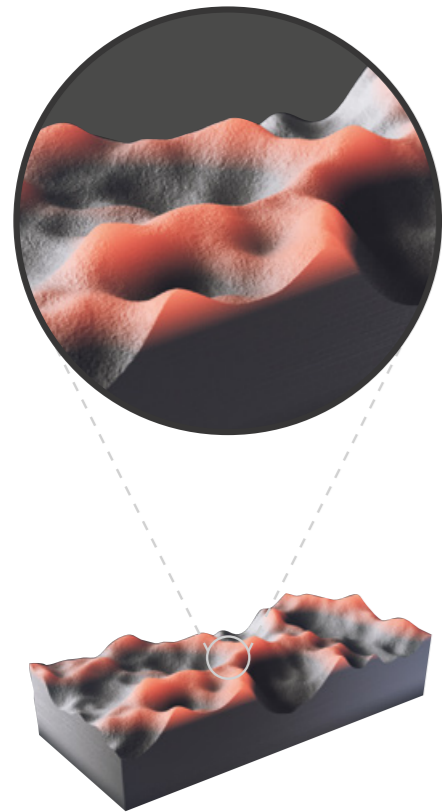

Traditional anti-slip surface

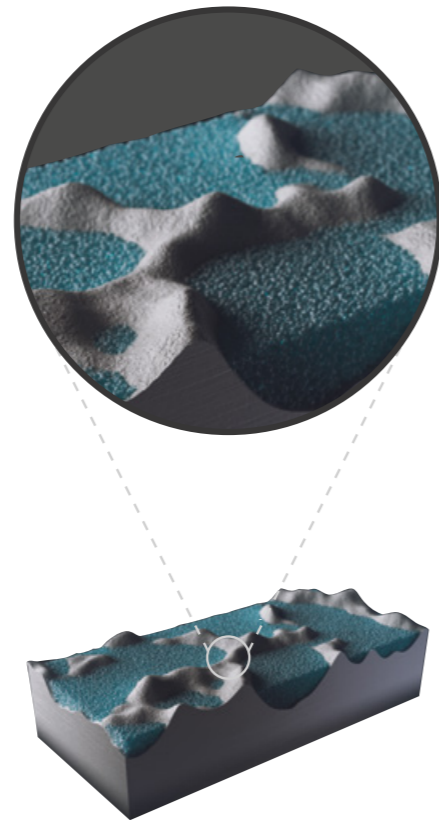

The innovative Sensitech Surface

Sensitech is the high-tech surface for indoor and outdoor settings created by Atlas Concorde Laboratories, patented in Europe. The surface combines high slip resistance performance with tactile softness. With Sensitech, the meaning of surface evolves and takes on a reassuring, pleasant and practical touch, making architectural spaces more comfortable and appealing.

Sensitech è la superficie ad alto coefficiente tecnologico per gli ambienti interni ed esterni realizzata dai Laboratori Atlas Concorde, brevettata in Europa. La superficie coniuga elevate prestazioni di resistenza allo scivolamento ad una maggiore morbidezza tattile. Con Sensitech il significato di superficie si evolve e assume un tocco rassicurante, piacevole e pratico, rendendo gli spazi architettonici sempre più confortevoli e appaganti.

MORE INFORMATION



Ethical identity



For Atlas Concorde, being Made in Italy is not just a prestigious certification of style, design, and production excellence, but an identity that involves all aspects of its business. For this reason, we identify with the values expressed by Confindustria Ceramica's ethical code, which guarantee absolute compliance with labor regulations, and with the marks Made in Italy and Ceramics of Italy, which certify the quality of authentic Italian style.

Per Atlas Concorde, Made in Italy non è solo un prestigioso attestato di stile, design ed eccellenza produttiva, ma un modo di essere che coinvolge tutti gli aspetti della propria attività. Per questo ci riconosciamo nei valori espressi dal codice etico di Confindustria Ceramica, che garantiscono il rispetto assoluto delle normative sul lavoro, e nei marchi Made in Italy e Ceramics of Italy, che certificano la qualità dell'autentico stile italiano.

Certifications

Company certifications / Certificazioni aziendali



Product declarations / Dichiarazioni di prodotto



Certifications for export to international markets*



Product certifications / Certificazioni di prodotto



Certification for buildings / Rating dell'edificio

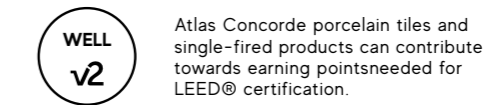

Ratings and memberships



* Shipments can be made in accordance with national requirements anywhere in the world, even in markets with complex customs procedures such as Egypt, Morocco and Kurdistan, thanks to our active cooperation with accredited certification bodies in each country. - Possibilità di spedizioni conformi alle prescrizioni nazionali ovunque nel mondo, anche in mercati con procedure doganali complesse come Egitto, Marocco, Kurdistan, grazie alla collaborazione sempre attiva con gli enti di certificazione accreditati in ciascun paese. - Dank unserer aktiven Zusammenarbeit mit den akkreditierten Zertifizierungsstellen in den einzelnen Ländern können die Sendungen in Übereinstimmung mit den nationalen Anforderungen überall auf der Welt versandt werden, selbst auf Märkten mit komplexen Zollverfahren wie Ägypten, Marokko und Kurdistan. - Possibilité d'expéditions conformes aux prescriptions nationales partout dans le monde, même sur les marchés dont les procédures douanières sont complexes comme l'Égypte, le Maroc ou le Kurdistan, grâce à la collaboration toujours active avec les organismes de certification homologués dans chaque pays. - Se pueden realizar envíos según la normativa nacional a cualquier parte del mundo, incluso a mercados con procedimientos aduaneros complejos como Egipto, Marruecos o Kurdistan, gracias a la cooperación permanente con los organismos de certificación acreditados en cada país. - Компания имеет возможность осуществлять поставки в любую точку мира в соответствии с национальными требованиями, даже на рынках со сложными таможенными процедурами, таких как Египет, Марокко, Курдистан, благодаря неизменно активному сотрудничеству с аккредитованными органами сертификации в каждой стране.

⁽¹⁾ Classificazione UPEC aggiornata al - Classement UPEC mis à jour au: 2024

⁽²⁾ Si consiglia la consultazione della pagina - On vous conseille de vous connecter à: <https://database.cstb.fr/holderdetails?UId=ETB-2094&AppRef=QB32>

⁽³⁾ Per ulteriori informazioni scrivere a - Pour tous renseignements complémentaires merci d'écrire à: france@atlasconcorde.it

⁽⁴⁾ Tutti i prodotti Atlas Concorde in gres porcellanato e in monocottura in pasta bianca possono essere utilizzati per progetti edili che seguono le linee guida del GREEN BUILDING COUNCIL e possono contribuire all'ottenimento del rating LEED V4 degli edifici.

All Atlas Concorde porcelain tiles and white-body single-fired products can be used for building projects that follow the guidelines of the GREEN BUILDING COUNCIL and can contribute to the achievement of the LEED V4 rating for buildings.

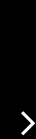



atlasconcorde.com

Copyright 2024 by Ceramiche Atlas Concorde S.p.A
(41042 Spezzano di Fiorano (MO) - Italia)
September 2024